

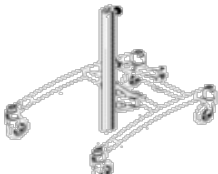

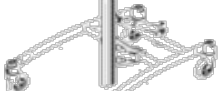

R82 Toucan



Utprovad av: _____ Brukare: _____

Telefon: _____ Datum: _____



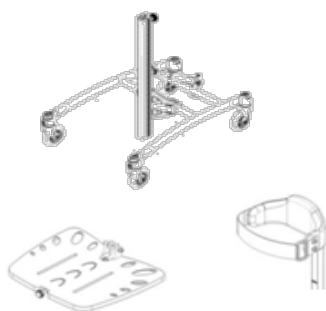





Beskrivning	Stl	Artikel nr.	Sesamnr
Ståstöd Toucan inkl. bröstplatta och fotplatta			
 röd	stl 1	31861001-1S	30072
 blå	stl 2	31861002-2S	52659
 blå	stl 3	31861003-3S	30073
 silver	stl 4	31861004-3S	40287
 silver	stl 5	31861005-3S	56087









Standardutförande

Delar	Beskrivning
Chassi	Aluminiumrör
Stopning	Svart PUR
Bröstplatta	Multijusterbar inkl ryggrem
Hjul	Punkteringsfria säkerhetshjul, skaterhjul transparent
Fotplatta	Höjd och vinkeljusterbar, mått 31x30 cm (stl 1), 43x36 cm (stl 2-5)

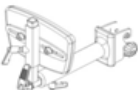
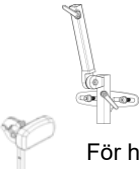
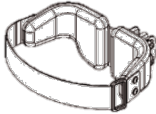
Tillbehör Toucan

Artikel		Storlek	Art nr	Sesamnr	
Bord med leklåda BxDj 31x9x10		stl 1-5 one size	31862501	27928	<input type="checkbox"/>
Bord med leklåda och bricka trä, BxDj 61x52 cm		stl 1 stl 2 stl 3 stl 4 stl 5	31861101 31861102 31861103 31861104 31861105	39496 52663 36947 28200 60497	<input type="checkbox"/> <input type="checkbox"/> <input type="checkbox"/> <input type="checkbox"/> <input type="checkbox"/>
Kan kompletteras med: Armstöd trä		par one size	31861111	31135	<input type="checkbox"/>
Polstringsplatta med olika utskärning inkl överdrag		Utskärning 400 mm 280 mm 350 mm	31862135-0 31862135-1 31862135-2	60739 60740 60741	<input type="checkbox"/> <input type="checkbox"/> <input type="checkbox"/>
Bord med leklåda och bricka plast, BxDj 61x57 cm		stl 1 stl 2 stl 3 stl 4 stl 5	31861121 31861122 31861123 31861124 31861125	61106 61107 61108 61109 56094	<input type="checkbox"/> <input type="checkbox"/> <input type="checkbox"/> <input type="checkbox"/> <input type="checkbox"/>
Kan kompletteras med: Armstöd för bord, plast Lekbåge för bord, plast			31861131 31861135	50525	<input type="checkbox"/> <input type="checkbox"/>
Bord		plast, grått 44x34 cm	stl 1-5 one size	31862515	51879 <input type="checkbox"/>
Förlängningsdel centerstag 80 mm		stl 1-5 one size	31861480	39462	<input type="checkbox"/>
Magplatta		13x9 cm	stl 1-5 one size	31861411	39499 <input type="checkbox"/>

Tillbehör Toucan

Artikel		Storlek	Art nr	Sesamnr			
Ryggstöd		13x9 cm	stl 1-5 one size	31861401 39498	<input type="checkbox"/>		
Stag huvudstöd		20 cm 33 cm	stl 1 stl 2	31861424-3 31861424-4	50758 50759	<input type="checkbox"/> <input type="checkbox"/>	
	För huvudstöd, se separat protokoll						
Sidostöd främre			stl 1 stl 2-3 stl 4-5	31861601 31861602 31861603	39491 31308 39492	<input type="checkbox"/> <input type="checkbox"/> <input type="checkbox"/>	
Sidostöd roterbart			stl 1 stl 2-3 stl 4-5	31861611 31861612 31861613	39489 39490 39487	<input type="checkbox"/> <input type="checkbox"/> <input type="checkbox"/>	
Sidostöd bakre			stl 1 stl 2-3 stl 4-5	31861501 31861502 31861503	39488 39485 39486	<input type="checkbox"/> <input type="checkbox"/> <input type="checkbox"/>	
Höftstöd		Small: Omkrets 47-64 cm, H 8,5 cm Medium: Omkrets 67-78 cm, H 11 cm Large: Omkrets 87-114 cm, H 14 cm	Small Medium Large	31861610 31861620 31861630	60500 51645 60501	<input type="checkbox"/> <input type="checkbox"/> <input type="checkbox"/>	
Bålstöd		Mått inre omkrets: 47-64 cm 67-78 cm 87-114 cm	Small Medium Large	31861810 31861820 31861830	60502 60503 60504	<input type="checkbox"/> <input type="checkbox"/> <input type="checkbox"/>	
Överdrag bålstöd			Small Medium Large	31869810-160 31869820-260 31869830-360	46173 50740 50741	<input type="checkbox"/> <input type="checkbox"/> <input type="checkbox"/>	
Mellandyna		S L	5,5x11 cm 5,5x16 cm	stl 2-5 stl 2-5	31861421 31861422	39493 39487	<input type="checkbox"/> <input type="checkbox"/>

Tillbehör Toucan

Artikel	Storlek	Art nr	Sesamnr
Knästöd 	stl 1	31861301	39494
	stl 2-3	31861302	31195
	stl 4-5	31861303	39495

Knästöd delbart



stl 1	31861311	39500
stl 2-3	31861312	35719
stl 4-5	31861313	39501

Andfötter, exkl remmar

För mag- och ryggstående.



17,5 cm	stl 0	3186149	60499
21,5 cm	stl 1+2	3186147	40006
24 cm	stl 3	3186148	16331

Fotremmar, par



kardborre	3185102	12319
plastspänne	3185096	12320

Fotsandal vikbar

för hel uppfällbar fotplatta inkl remmar



stl 1	31861221	39456
stl 2-3	31861222	39457
stl 4-5	31861223	39476

Fotplattor, delade inkl vikbar fotsandal m. remmar

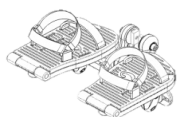

stl 1	31861201	39531
stl 2-3	31861202	39532

Hälstöd



BxH 10x4 cm	S	31861251	30023
BxH 14,5x4 cm	L	31861252	60498

Reservdelar

Artikel	Art nr	Sesamnr		
Bröstplatta 	B x D x H			
	20-27 x 7,5 x 11 cm	stl 1	31861704	50561
	20-27 x 7,5 x 11 cm	stl 2-3	31861702	31226
	25-32 x 10,5 x 16 cm	stl 4	31861703	31136