



# R82 Stingray

Utprovad av: \_\_\_\_\_





Märkes: \_\_\_\_\_





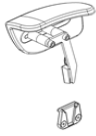
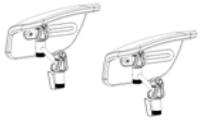
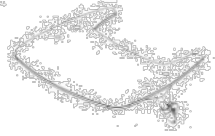

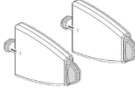



Telefon: \_\_\_\_\_

Datum: \_\_\_\_\_

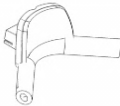
Beskrivning	Stl	Artikel nr.	Sesam nr.
<b>Chassi Stingray</b> 	7" svängbara framhjul	318722222	<b>52010</b> <input type="checkbox"/>
<b>Sits Stingray</b> med fotstöd 	stl 1 stl 2	318711120 318712220	<b>52294</b> <input type="checkbox"/> <b>52295</b> <input type="checkbox"/>
<b>Dyna, set</b> 	Röd	stl 1 318750512 stl 2 318750522	<b>48960</b> <input type="checkbox"/> <b>48961</b> <input type="checkbox"/>

## Tillbehör Stingray

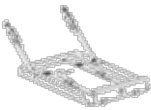
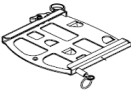
Artikel		Art nr	Sesam nr.	
<b>Höftstöd</b> komplett par		stl 1	318740230	48919 <input type="checkbox"/>
		stl 2	318740240	48920 <input type="checkbox"/>
<b>Höftstöd multijusterbara</b> komplett par Gör sitsen ännu smalare		stl 1	318740250	48921 <input type="checkbox"/>
		stl 2	318740260	48922 <input type="checkbox"/>
<b>Bord</b> transparent plast inkl fäste		stl 1	318720010	48915 <input type="checkbox"/>
		stl 2	318720020	48916 <input type="checkbox"/>
grå plast, 44x34 cm			318776350	56315 <input type="checkbox"/>
<b>Sufflett</b> svart		stl 1	318740110	48917 <input type="checkbox"/>
		stl 2	318740120	48918 <input type="checkbox"/>
<b>Bålstöd</b> par		stl 1	318720301	48923 <input type="checkbox"/>
		stl 2	318720302	48924 <input type="checkbox"/>
<b>Skydd justeringsknapp bålstöd</b>		par	318720360	<input type="checkbox"/>
<b>Bendelare</b>		stl 1	318720501	48927 <input type="checkbox"/>
		stl 2	318720502	48928 <input type="checkbox"/>
		stl 3	318720503	48929 <input type="checkbox"/>
<b>Kil sits</b> 36x16x2,5 cm		stl 1-2	318720405	<input type="checkbox"/>

<b>Handbåge</b> inkl fäste		stl 1	318720401	48925	<input type="checkbox"/>
		stl 2	318720402	48926	<input type="checkbox"/>
<b>Huvudstöd, svart</b>		stl 1	318740810	56342	<input type="checkbox"/>
		stl 2	318740820	56343	<input type="checkbox"/>
<b>Huvudstöd, format</b> B24 cm D12 cm B28 cm D15 cm		stl S	318720831	50691	<input type="checkbox"/>
		stl L	318720832	50692	<input type="checkbox"/>
<b>Huvudstöd 2-delat</b>		one size	318720870		<input type="checkbox"/>
<b>Huvudstöd, anatomiskt</b>		stl M	318720862	48934	<input type="checkbox"/>
		stl L	318720863	48935	<input type="checkbox"/>
<b>Beslag separat huvudstöd</b>			318720850	48933	<input type="checkbox"/>
<b>Transportfäste</b>			318720902	50038	<input type="checkbox"/>
<b>Varukorg</b>			318720600	48930	<input type="checkbox"/>
<b>Hållare för syrgasflaska</b> Kräver transportfäste på baksidan av ramen.			318776295	48938	<input type="checkbox"/>
<b>Hållare för ventilator</b> Svart. Max last 20 kg. Mått: 34 x 44 cm (BxL) Kräver centralbroms			318776290	48937	<input type="checkbox"/>
<b>Adapter chassi</b> För kombination av ny sits med gammalt utförande av chassi.			318722020		<input type="checkbox"/>
<b>Adapterplatta sits</b> För kombination av nytt chassi med gammalt utförande av sits.			318712020		<input type="checkbox"/>
<b>Västar och bälten</b> <i>Se separat utprovningssprotokoll</i>					